

Applies only to products with serial number 1804-61001 and later

COMPLETE USER MANUAL

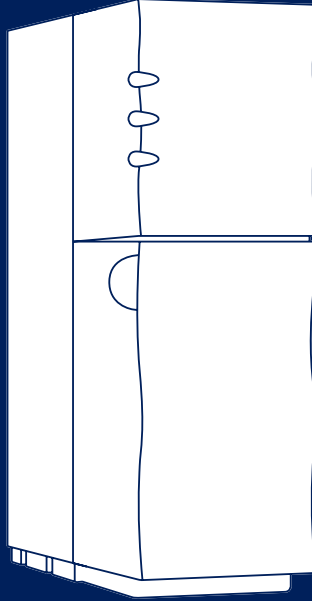

BLUEWATER SPIRIT

WATER PURIFIER



CONTENTS

INTRODUCTION	03
About this manual	03
Limited warranty	03
Environment information	03
Disposal	03
Symbols	03
Safety instructions	04
Safety information	04
PRODUCT OVERVIEW	06
Models	06
Spirit outside	06
Spirit inside and replacement components	06
Move the water purifier	08
SYSTEM OVERVIEW	09
System description	09
Intended use	09
Leak protection system	10
Low pressure protection	10
Water production	10
INSTALLATION	12
Unpack Spirit	13
Position Spirit	13
Install clean water faucet	14
Install feed water connection	14
Install drain water connection	15
Connect the water purifier	15
Flush Spirit	16
Do a check for leaks	16
MAINTENANCE	17
Each month	17
Each 4-6 months	18
Each year	21
Other	21
TECHNICAL INFORMATION	27
Technical data	27
Requirements on feed water to water purifier	27
TROUBLESHOOTING	28
How to solve simple problems	28

INTRODUCTION

About this manual

This manual contains complete user instructions for the Spirit. It gives you the necessary instructions to safely install, operate, do maintenance and do troubleshooting on the device.

Original language

The original language of this instruction is English.

Printing options

This manual is made to be printed as a double sided A4 or A5 booklet.

Limited warranty

Refer to www.bluewatergroup.com/warranty for more information on Limited warranty.

Environment information



80% of the the water purifier components and its packaging have a label to help you recycle and discard it correctly. The water purifier is more efficient when it cleans water for longer periods. Example: do not fill a glass with water. Fill a jug instead.

Disposal

At the end of the water purifier's life, disconnect the plug from the electrical supply and cut the cable at the point where it enters the appliance. Make sure that children do not play with the left-over cable. Contact your local authority for information about where the water purifier can be left, or contact your dealer.



Appliances bearing this symbol must be deposited at the designated local reception point for the disposal of electrical and electronic equipment. This product may not be disposed by using the normal household refuse collection processes.

Symbols

The following symbols can be found on the water purifier:

Symbol	Description	Symbol	Description
The logo for NSF/ANSI Gold Seal certification, featuring a circular seal with the text 'NSF/ANSI GOLD SEAL' and 'NSF INTERNATIONAL'.	The WQA Gold Seal is proof that the water purifier has been independently tested and is certified against NSF/ANSI 58 and CSA Standard B483.1. It has also been tested and certified against NSF/ANSI 372.	The ETL Listed Mark logo, featuring the letters 'ETL' inside a circle with 'LISTED' and 'US' below it, and the Intertek logo underneath.	The ETL Listed Mark is proof that the device has been independently tested and meets the applicable published standard.

Safety instructions

Before you install or operate the device, you must read the safety information. Obey the instructions in this manual to prevent injuries or damage to the equipment. This manual contains CAUTIONS and NOTES that are applicable for the safe operation of the device.

-  A CAUTION identifies conditions that can cause injury, or damage to the equipment. Obey the instructions and do not continue until all conditions are accepted and engaged.
-

-  A Note identifies important information for a trouble free and optimal use of the water purifier.
-

Safety information

-  Install the water purifier in accordance with local regulations. If you are not sure, contact a Bluewater dealer for aid. Bluewater has no responsibility for installation of the water purifier.
-

-  Be aware! When the system has been on standby, turn on the faucet and let the water run until the service light stops flashing before using or drinking the water. Do not use or drink the water until the service light stops flashing.
-

-  Store the water in non-corrosive vessels.
-

- This appliance can be used by children who are more than 8 years old. It can also be used by persons with reduced physical, sensory or mental capabilities or lack of experience and knowledge, if they have been given supervision or instruction about the use of the appliance in a safe way and understand the hazards involved.
-

Children shall not play with the appliance. Cleaning and user maintenance shall not be made by children without supervision.

-  Do not repair or modify parts of the water purifier. This can make it operate incorrectly, and lead to injury and damage not covered by the warranty.
-

Spirit is a reverse osmosis system. It contains a replaceable membrane that is very important for effective reduction of total dissolved solids (TDS). Replace this membrane regularly.



Test the cleaned water periodically, at least one time every year, to make sure that Spirit performs correctly. If the water is not clean, tastes or smells bad, do not drink it.

Only approved Bluewater staff can do servicing and repairs on the water purifier. Only use original replacement cartridges and parts from Bluewater. For the spare parts catalogue and contact information for purchases, see www.bluewatergroup.com.



The feed water has to follow the requirements stated in "Technical information" on page 30.



Test the purified water at least once per year. Do not drink it if there is any indication that the water is not potable, such as smell, taste, cloudiness or presence of particles.



Installation must comply with applicable local plumbing codes and regulations.



Only connect the water purifier to one clean water faucet supplied by Bluewater. Do not connect it to other pipes, tanks or dishwashers.



Do not put or keep objects on top of the water purifier. Do not put the water purifier in water.



Connect the water purifier to an earthed electrical supply. Use a socket that is easy to access after installation. Only an approved electrician must do permanent wiring on the system. A safety switch must be installed on the system. Incorrect installation can lead to damage, or make the water purifier dangerous to use.



Do not use the power cord if there are visible signs of damage on it. If the power cord is damaged, a qualified electrician must replace it in order to prevent danger.



If the water purifier is disconnected from water and electricity for >5 days, store it as described in "Put into storage" on page 24.

PRODUCT OVERVIEW

Models

Model	Spirit 300	Electronically controlled	Bluewater faucet
	Spirit 300Cp	Pressure controlled, compatible with household appliances	Faucet adapted to reverse osmosis

Spirit outside

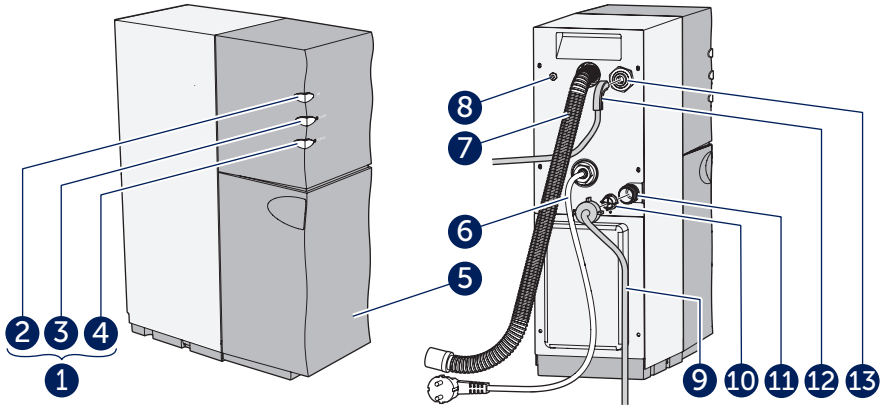

Figure 1. Spirit outside

Pos	Description	Pos	Description
1	Control panel	8	Electrical connection for faucet (Spirit 300)
2	ON light	9	Feed water hose
3	FILTER light	10	Grid filter
4	SERVICE light	11	Feed water connection
5	Front cover	12	Clean water hose
6	Power cord	13	Clean water connection
7	Drain water hose		

Spirit inside and replacement components

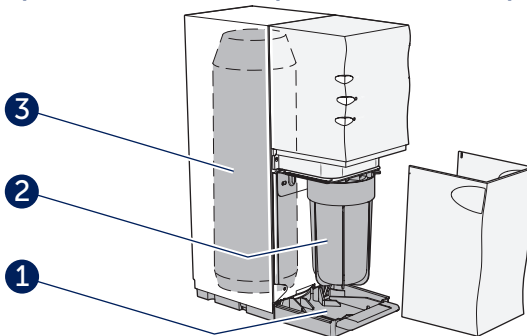

Figure 2. Spirit inside

Pos	Description	Art. no
1	Base plate	
2	Prefilter, carbon filter, granulated	919240004
3	Reverse osmosis membrane	
	Membrane service kit, type HR (High Rejection)	155007301-SP
	Membrane service kit, type HF (High Flow)	150759380-SP

Control panel

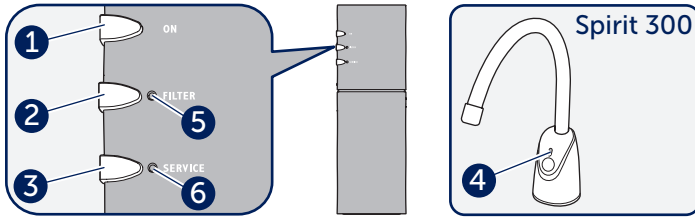













Figure 3. Control panel

Pos	Light/button	Description
1	ON light	On:  The water purifier is connected and operates correctly.
2	FILTER light	Flashes quickly:  The feed water pressure is too low.
		Flashes:  The water purifier operates. The filter must be replaced.
		On:  The water purifier has stopped. The filter must be replaced.
3	SERVICE light	Flashes quickly:  The water quality meter does not function.
		Flashes:  Decreased water quality.
		On:  The water purifier has stopped. The water quality has decreased.
2 & 3	FILTER and SERVICE light	Flashes quickly:   There is a water leakage or condensation on the base plate.
4	Faucet lights	Green:  Shows good water quality (this can take up to 120 seconds).
		Flashes yellow:  The water quality has decreased. Wait for the green light.
		Yellow:  The water purifier has stopped. Look at the control panel.
5	FILTER button	
6	SERVICE button	

Data plate

The data plate is located behind the filter.

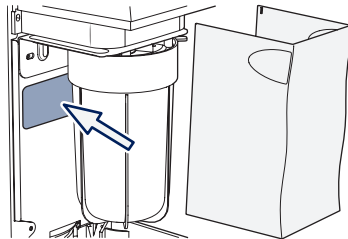

Figure 4. Data plate

Move the water purifier



Always transport the water purifier upright.
Install according to “Installation” on page 12.



Put the water purifier into storage if it will not be used for 4 months or more, or if it is to be disconnected from the water and electricity for >5 days, see “Put into storage” on page 24.

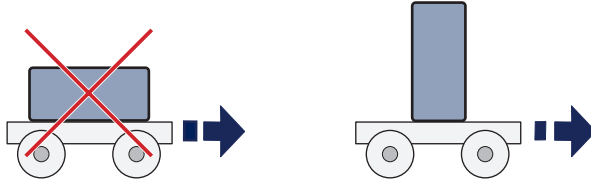

Figure 5. Move the water purifier

SYSTEM OVERVIEW

System description

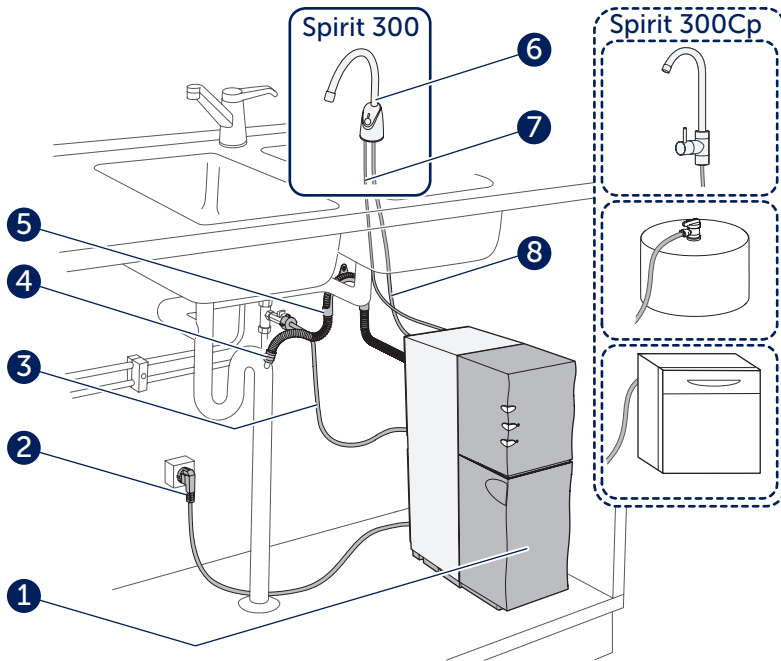

Figure 6. System overview, example of a Spirit installation

Pos	Description	Pos	Description
1	Water purifier	5	Bracket for drain water hose
2	Power cord	6	Bluewater faucet
3	Feed water hose	7	Clean water hose
4	Drain water hose, installed with an air gap	8	Faucet electrical connection (Spirit 300)

Intended use

The water purifier is intended to produce purified water. Do not use it for any other purpose. Any use beside indoor home environment and for purposes other than purifying water for household use is considered as unintended use and will automatically void your warranty.

The electronically controlled Spirit 300 is intended to produce the quantity of water that is normally required for cooking and drinking in a household. The pressure controlled Spirit 300Cp can be connected to other devices such as dishwashers.

Leak protection system

A sensor at the bottom of the water purifier senses water leaks. If there is a leak, the feed water supply is stopped. The water purifier cannot be started again until the leak has been repaired.

Low pressure protection

 If Spirit stops because of low pressure, the cause of the low pressure must be removed. If not, Spirit can be permanently damaged.

Low pressure restart function

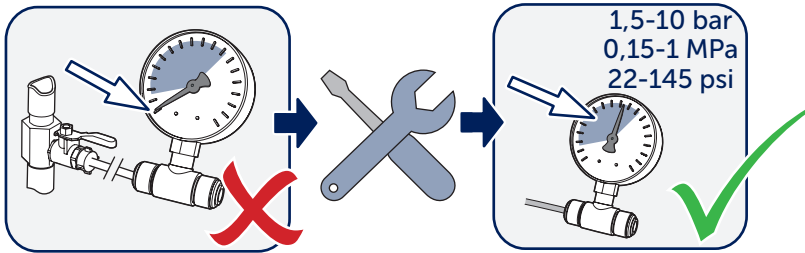

Figure 7. Low pressure restart function

 Only included in models suitable for commercial use.

When Spirit has stopped because of a low pressure problem (feed water), water production can be started manually by pushing the filter button 5 seconds.

The low pressure restart is a function to ensure maximum availability of water.

Spirit starts automatically when it has stopped because of low pressure. It tries to start three times: after 3 minutes, after 20 minutes and after 4 hours. If the water pressure is not sufficiently high after three tries, Spirit will stop.

Water production

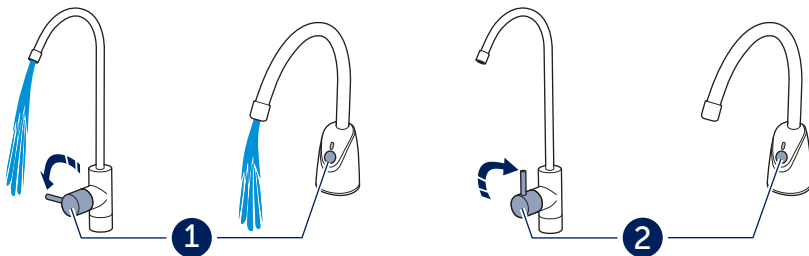

Figure 8. Water production on/off

Automatic flush

An automatic flush will be performed if one of the conditions below are fulfilled:

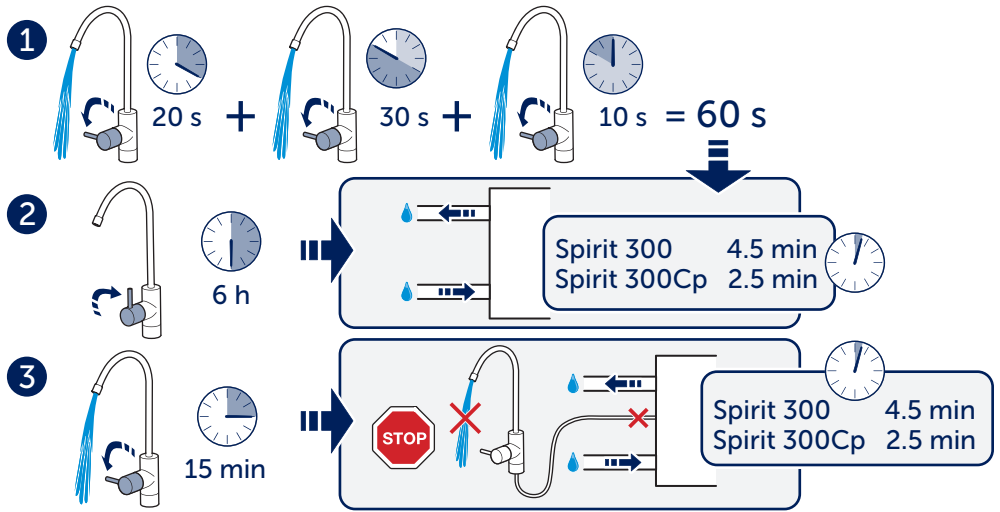









Figure 9. Automatic flush

Pos	Description
1	Flush after drawing water. Production cycles shorter than 60 seconds are added together, and flush takes place when total drawing time exceeds 60 seconds.
2	The water purifier in standby mode. Spirit is connected to water and power and it is more than 6 hours since the last flush.
3	Flush after maximum operation time 15 minutes. The next production cycle can be started immediately after completed flush.

INSTALLATION

-  Install the water purifier in accordance with local regulations. If you are not sure, contact a Bluewater dealer for aid. Bluewater has no responsibility for installation of the water purifier.
 -  Install the water purifier in a vertical position on a horizontal surface. Make sure that hose and cables can move freely when the water purifier is installed.
 -  Plumbing must be done by an approved plumber. Obey local rules for plumbing and sanitation if you do work yourself.
 -  Installation must comply with applicable local plumbing codes and regulations.
 -  Only connect the water purifier (only Spirit 300) to one clean water faucet supplied by Bluewater. Do not connect it to other pipes, tanks or dishwashers.
 -  Only connect the water purifier to the cold water supply. The water must be of sufficient quality and fulfill the requirements on feed water.
 -  Use the hose set that is supplied with the water purifier. Do not use used hose sets again.
-

Unpack Spirit

 **Warning!** Discard the packing material. It can cause injury to children if they play with it.

 Make sure that Spirit shows no signs of damage, and that no accessories are missing. Tell the Bluewater dealer about missing parts, damage and other problems. Tell the transport company immediately if Spirit is damaged during transport.

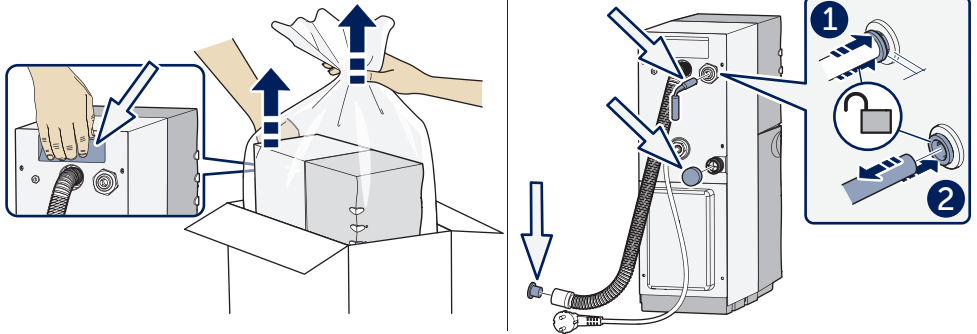

Figure 10. Unpack Spirit

Position Spirit

 Put Spirit in a vertical position on a horizontal surface below the kitchen sink. Make sure that the surface can support Spirit.

Position Spirit near the cold water supply, the drain and an earthed electrical supply.

- Make sure that it is easy to see the control panel.
- Make sure that the front cover can be opened to get access to the prefilter.
- Hose and cables can go in all directions from the connection point. Make sure that nothing can crush them or cause damage to them.

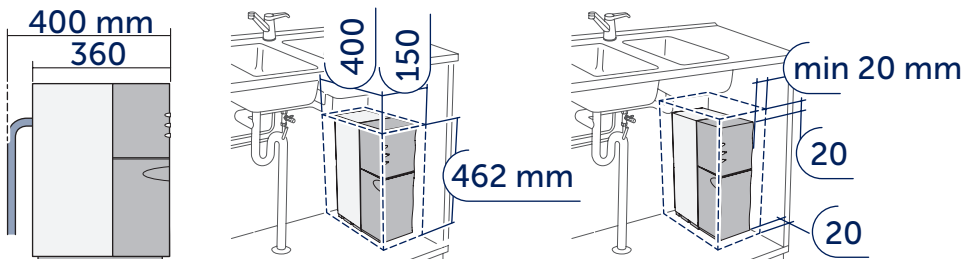

Figure 11. Position Spirit under the kitchen sink

Install clean water faucet



Make sure there is enough space for the plastic nut B underneath the sink.

Measurement A must be at least 25 mm.

Make sure there is enough space for the faucet above the sink.

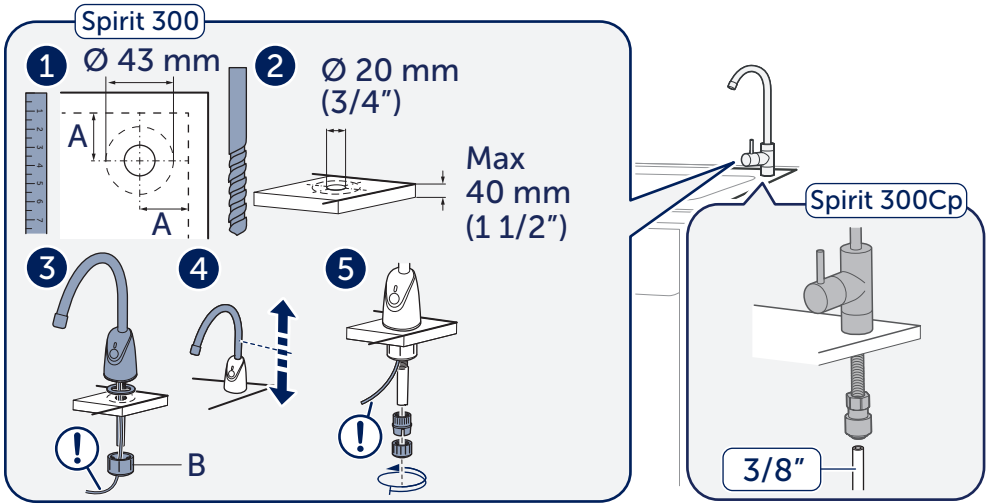

Figure 12. Install clean water faucet

Install feed water connection



Only connect the water purifier to the cold water supply.

The water must be of sufficient quality and fulfil the requirements on feed water.

The water purifier is connected to cold water via the feed water hose. See "Requirements on feed water to water purifier" on page 27.

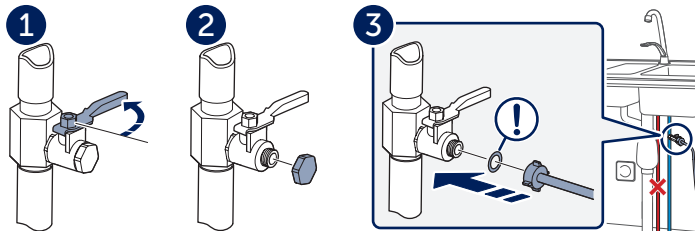



Figure 13. Install feed water connection

Install drain water connection

 Install the drain water hose with an air gap.

 The flushed water goes through the drain water hose to the drain water outlet. This hose can be a maximum of 4 m long. The minimum internal diameter is 13 mm.

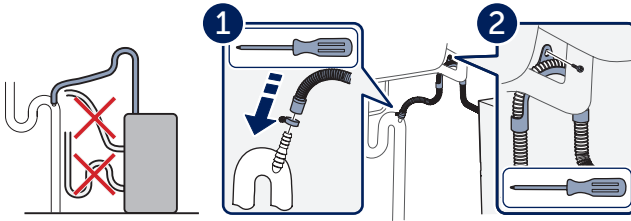



Figure 14. Install drain water connection

Connect the water purifier

 Do not connect the clean water hose to equipment before Spirit has been flushed.

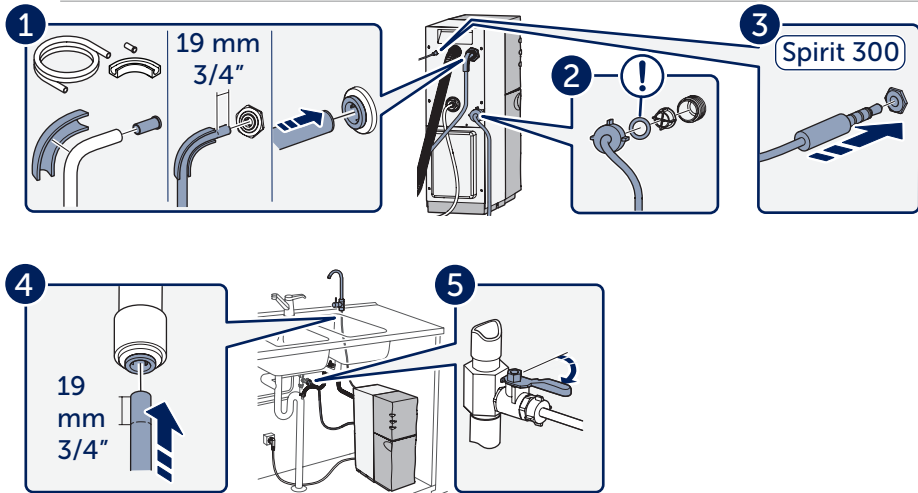

Figure 15. Connect the water purifier

Flush Spirit



Do not drink the water when the water purifier flushes. It is not safe to use.

The water purifier should always be flushed:

- when it is new and has not been used
- when it is installed again after storage/freeze protection
- when it has been cleaned
- when the membrane has been replaced.

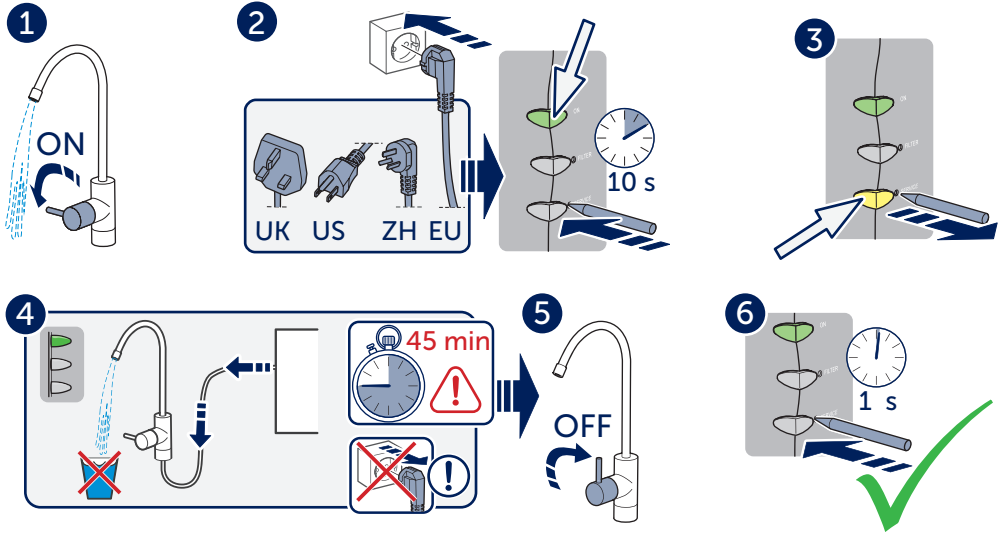

Figure 16. Flush Spirit

Do a check for leaks



The hose connections must be tight!

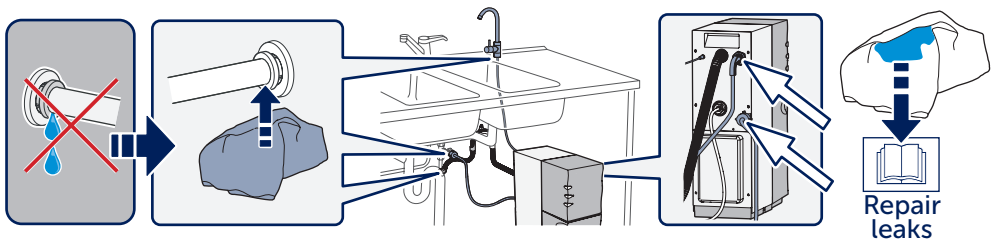



Figure 17. Check for leaks

MAINTENANCE

 Regular maintenance is important for correct function and long term operation. Only educated and approved personnel can do the maintenance.

 The water quality controls the maintenance frequency. If the feed water is of low quality, do maintenance more often.

Each month

Do a check for leaks

See "Do a check for leaks" on page 16.

Repair leaks

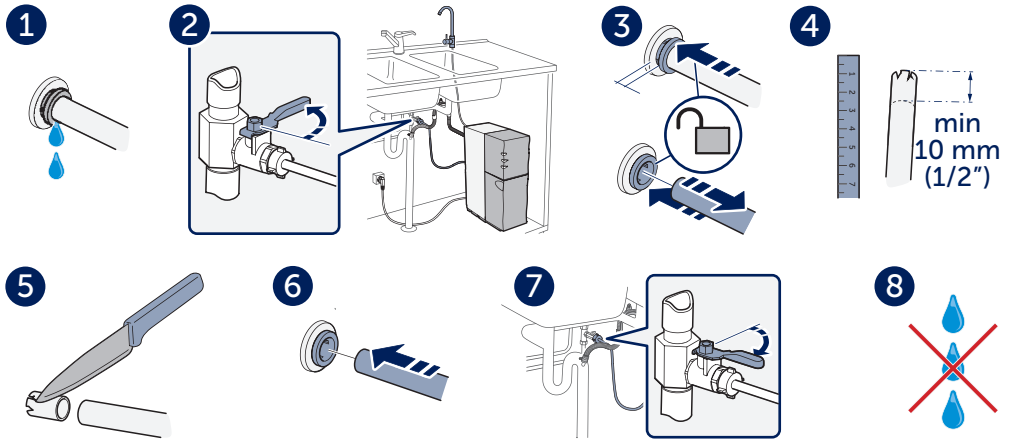

Figure 18. Repair leaks

Wipe off condensation from base plate

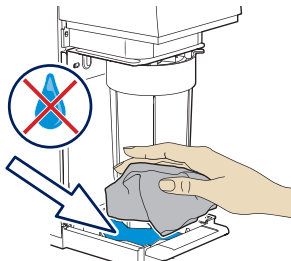

Figure 19. Wipe off condensation from base plate

Each 4-6 months

Descal



The descaling product is harmful. Keep it where children cannot get it. Clean your hands when you have used it.



Order the descaling product from a Bluewater dealer.

Frequency depending on water quality and usage!



To extend the water purifier lifetime: Descal Spirit with 6 month intervals or when the flow is decreased.



If Spirit has been descaled and the filters have been replaced, but the water flow cannot be restored, contact your Bluewater dealer.



The descale takes approximately 10 hours. Do not use the water purifier during this time.

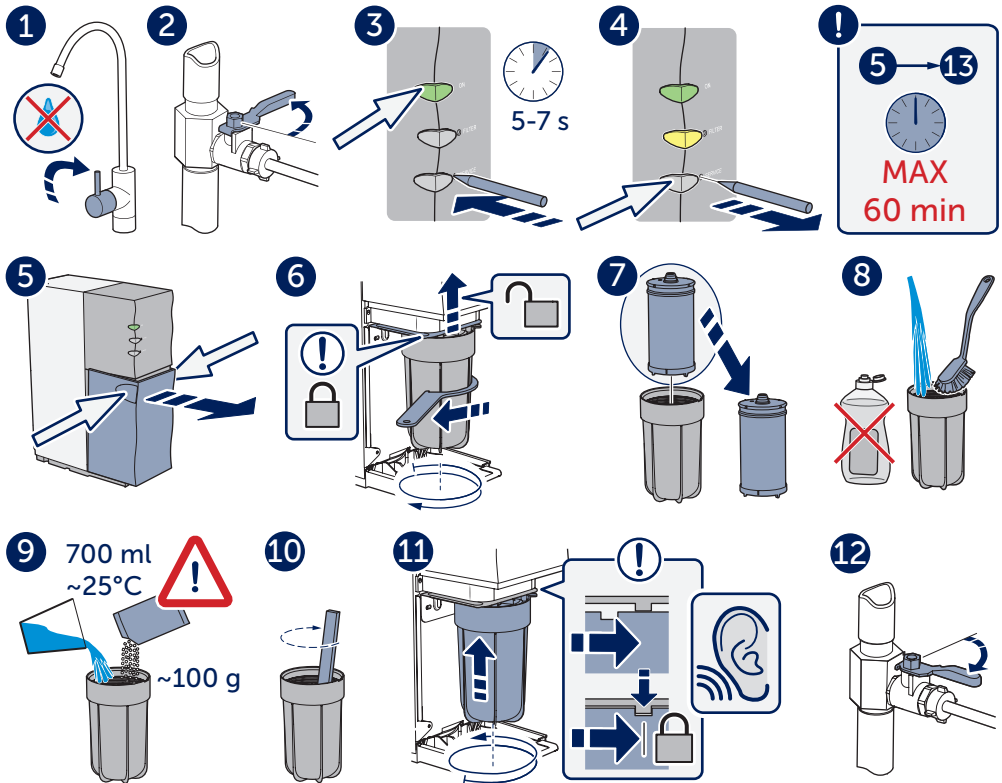

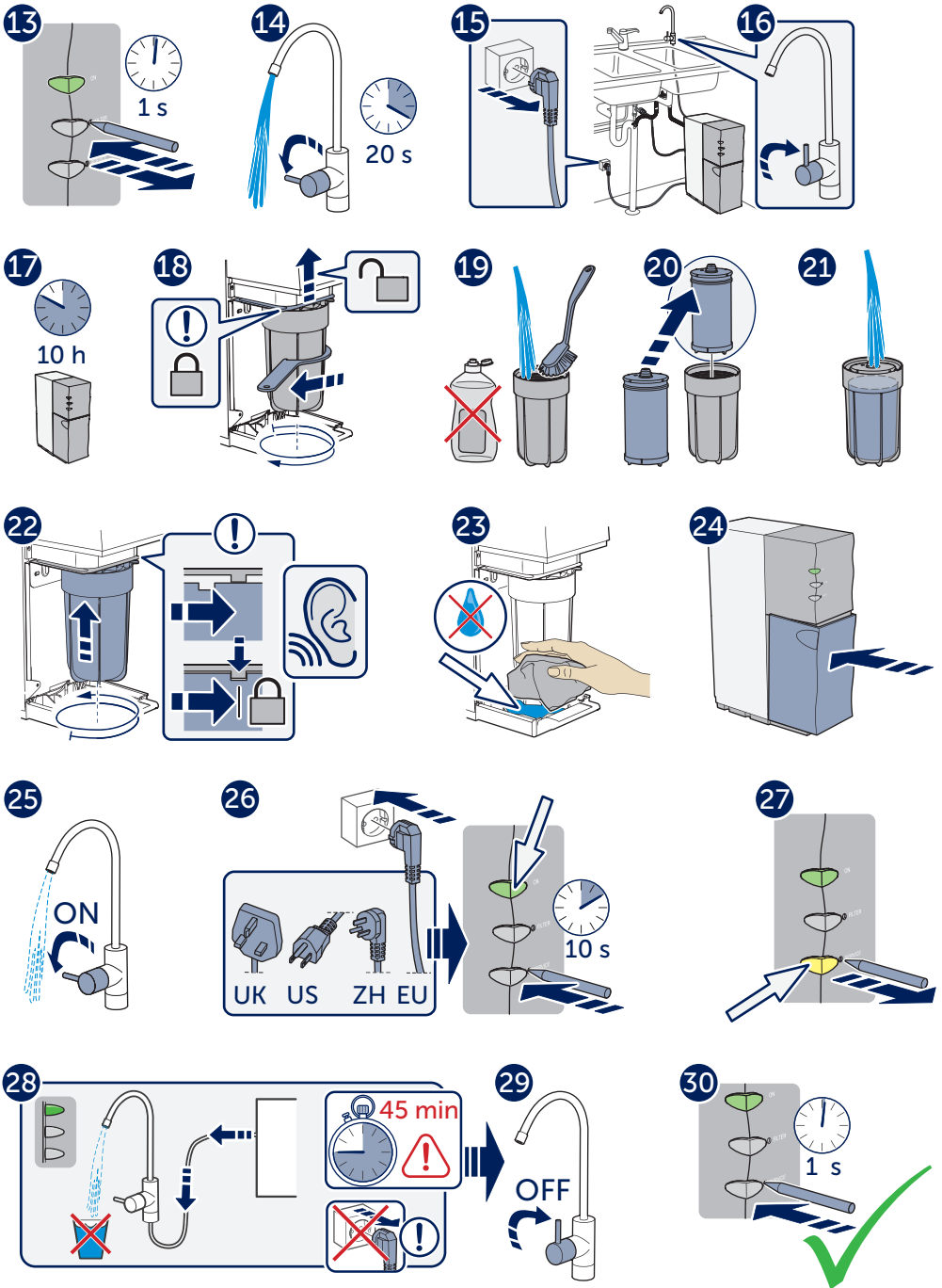

Figure 20. Descal and flush

Replace prefilter

Replace the filters after what comes first of 4-6 months or 18 925 l (5 000 gal) of purified water.

Order filters from a Bluewater dealer.

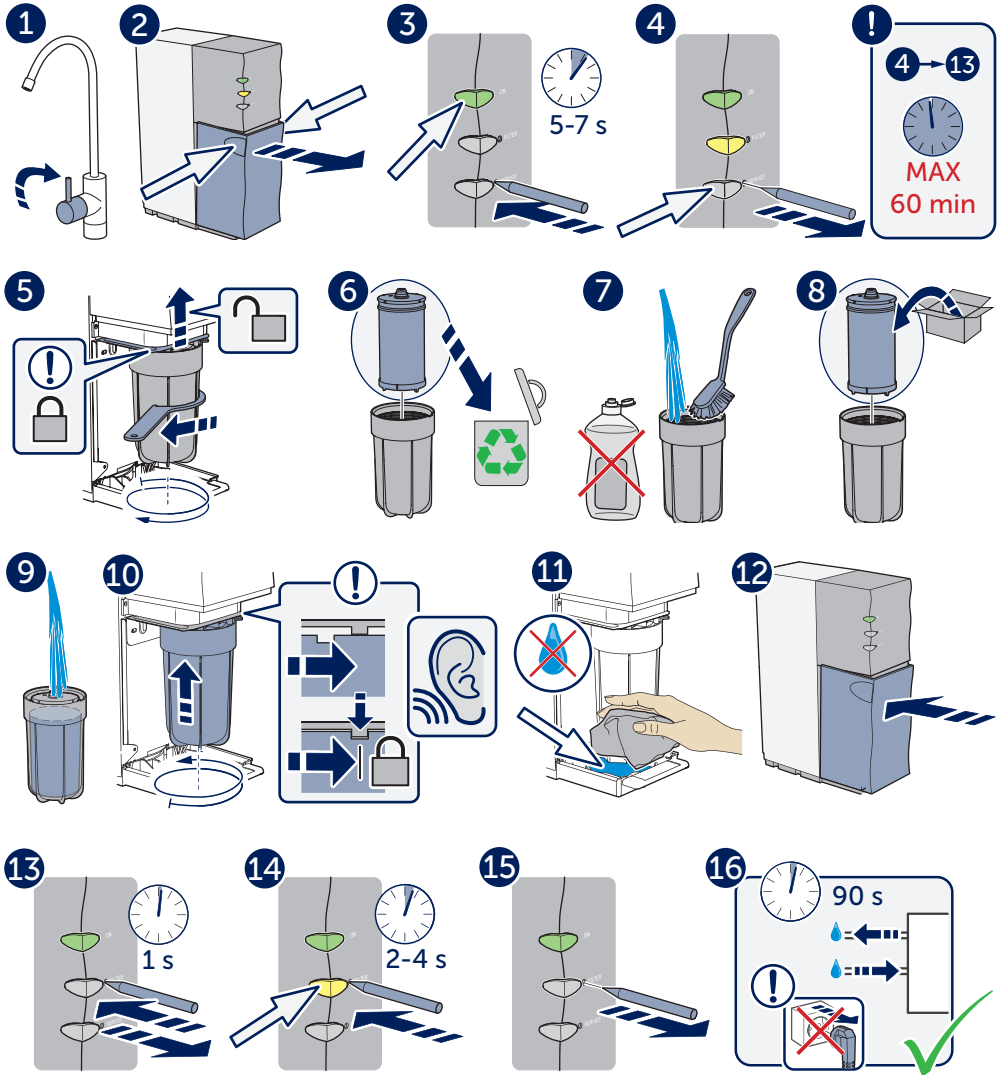



Figure 21. Replace prefilter

Each year

Test the water

 An approved lab must do a test of the water that is cleaned by Spirit at least one time every year, if the feed water has been classed as unfit.

Other

Clean the grid filter

 The grid filter in the feed water connection catches larger particles. If the flow is decreased or if Spirit makes a noise, the grid filter can be blocked.

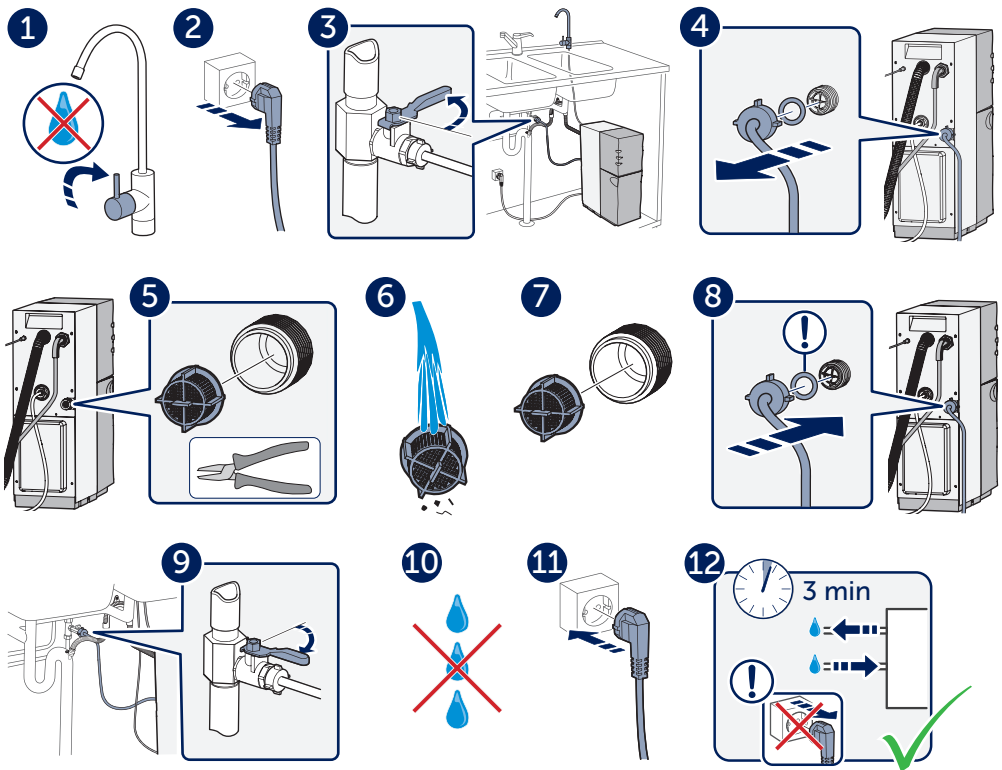



Figure 22. Clean the grid filter

Use disinfectant to clean the system

 Disinfectant is harmful! Keep it where children cannot get it.
Clean your hands when you have used it.

 Use sodium hypochlorite (NaClO) without added color or fragrance additives.

 Disinfect the water purifier when the water tastes or smells bad.

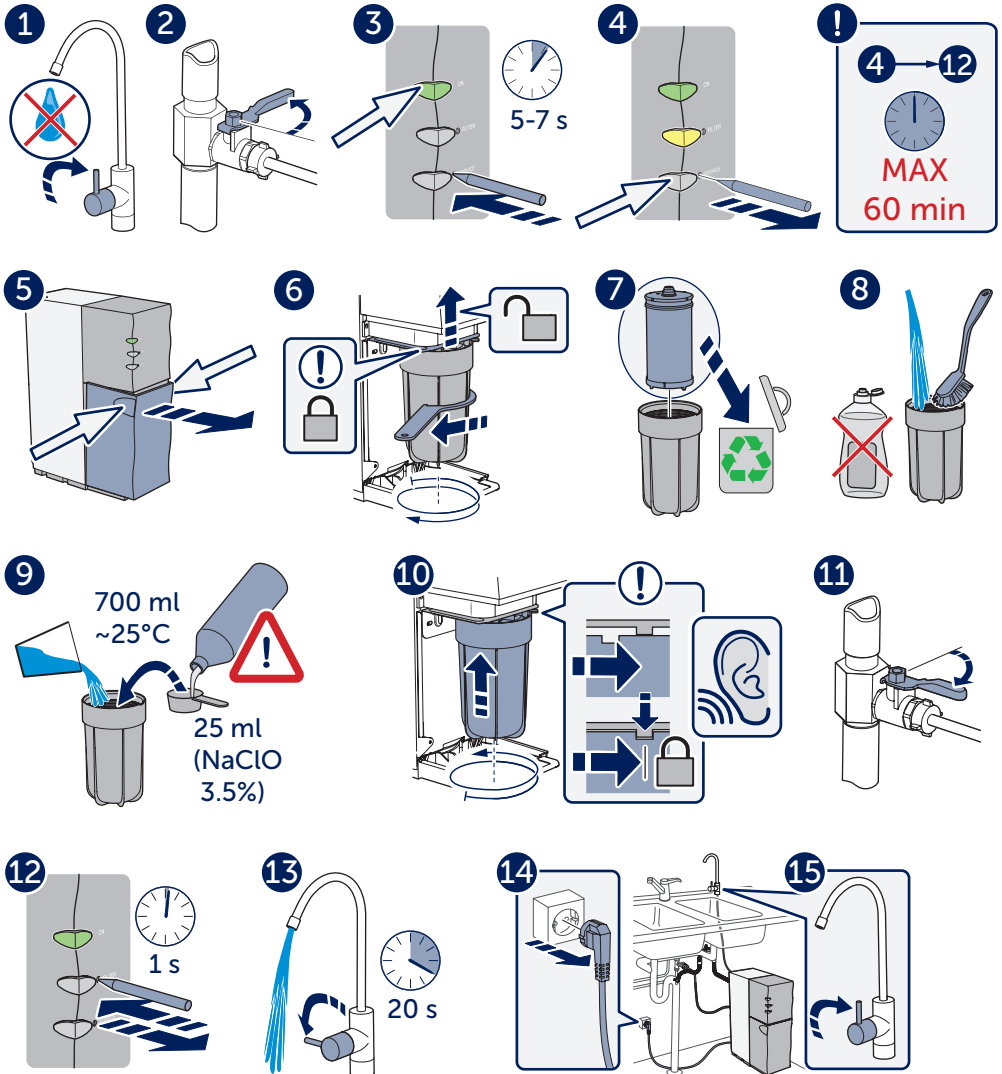

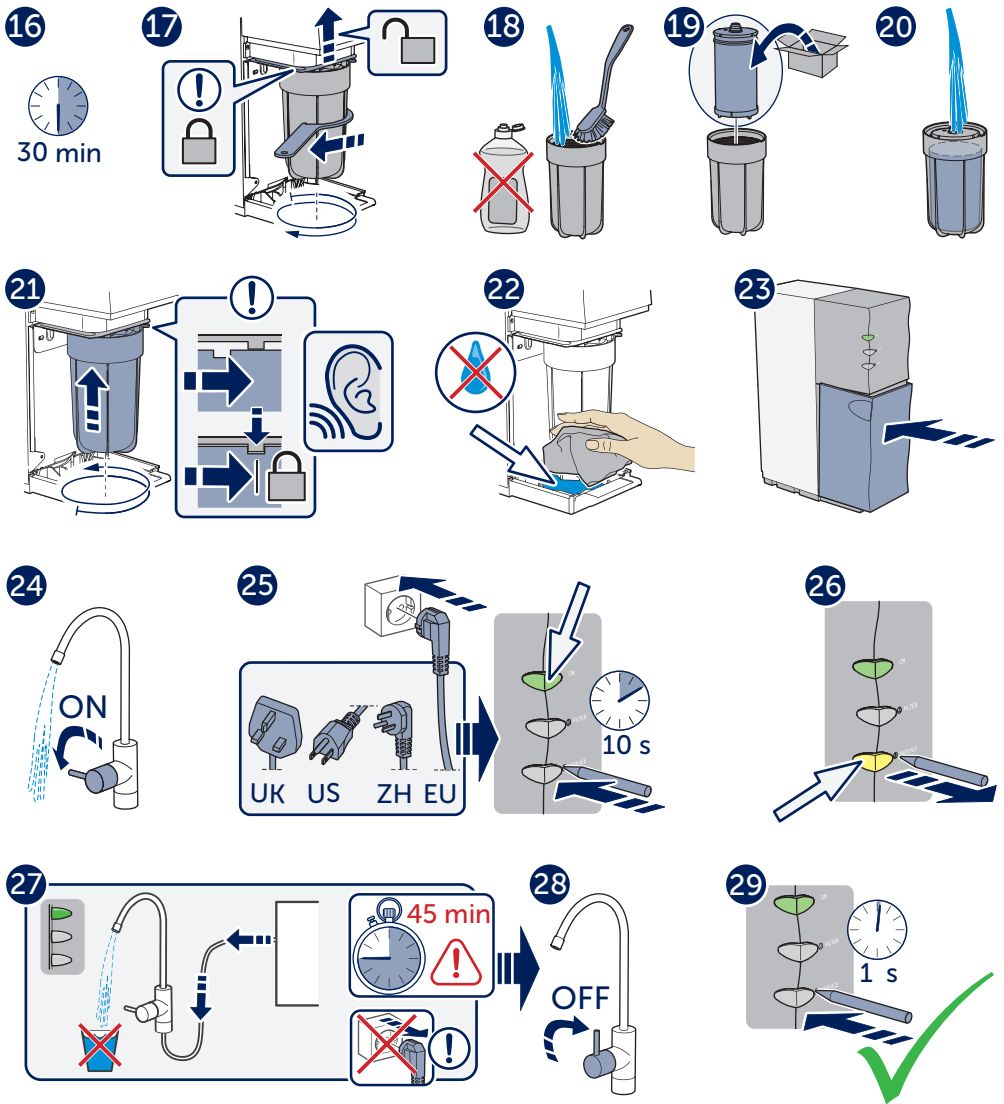



Figure 23. Use disinfectant to clean the system, and flush

Put into storage

 Preserving agent is harmful! Keep it where children cannot get it. Clean your hands when you have used it.

 Put the water purifier into storage if it will not be used for 4 months or more, or if it is to be disconnected from the water and electricity for >5 days.

 Order the preserving agent from a Bluewater dealer.

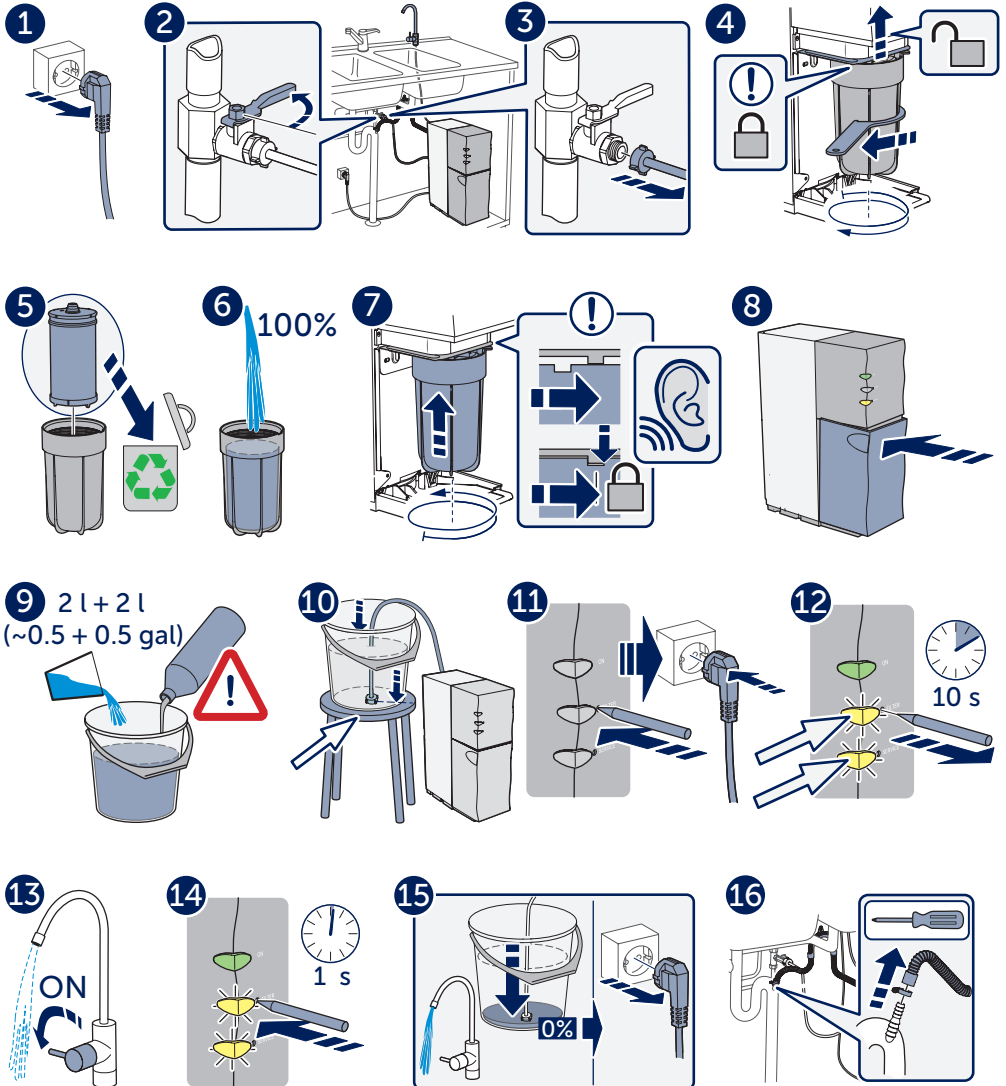

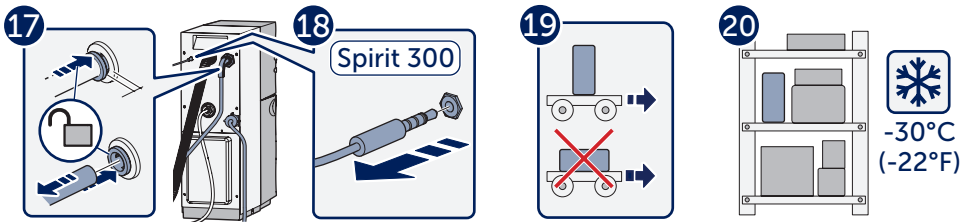
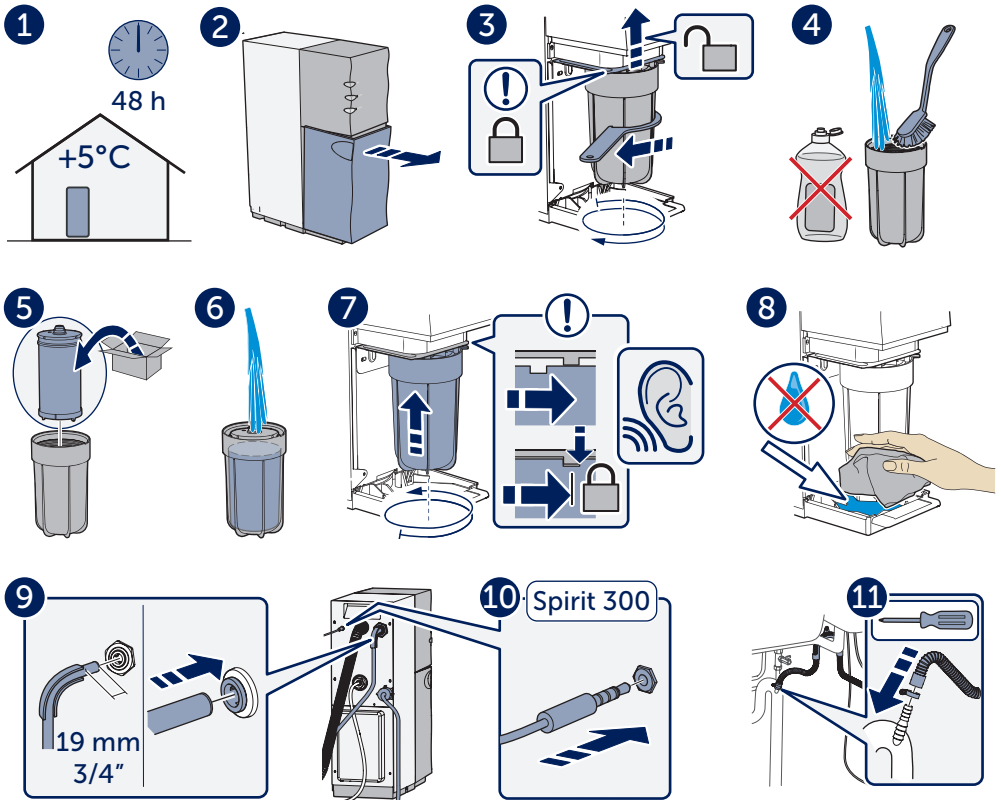

Figure 24. Put into storage

Reinstall after storage

⚠ Preserving agent is harmful! Keep it where children cannot get it.
Clean your hands when you have used it.



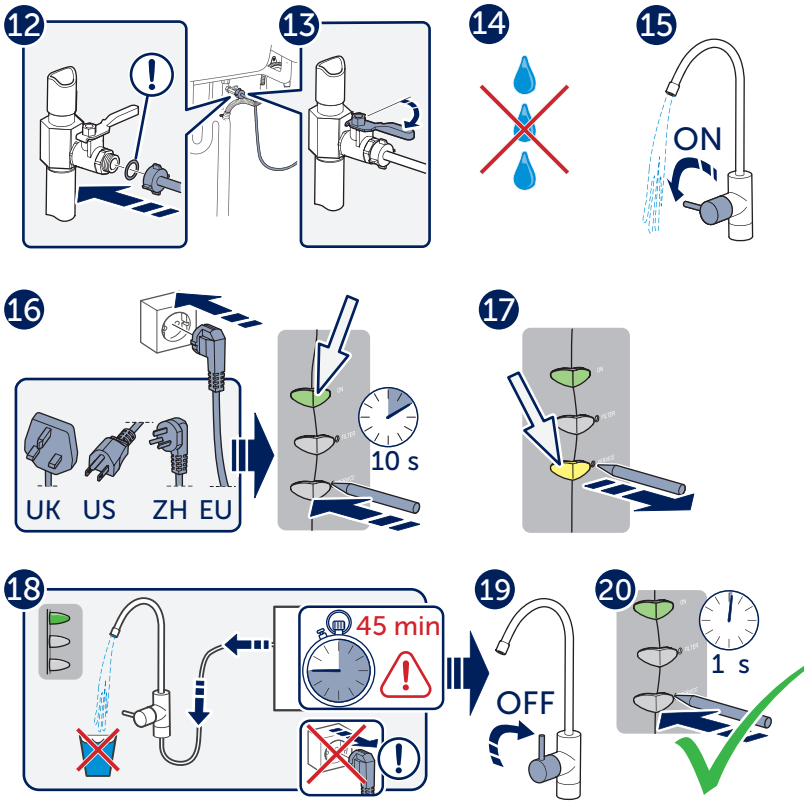



Figure 25. Reinstall after storage and flush

TECHNICAL INFORMATION

Technical data

Parameter/Model	Spirit 300	Spirit 300Cp
Size WxDxH [mm (")]	150x360x462 (5.9x14.3x18.2)	150x360x462 (5.9x14.3x18.2)
Weight [kg (lbs)]	15 (33)	15 (33)
Power supply, earthed supply Power supply, earthed supply US	220-240 V, 50-60 Hz, 10 A, 120 V, 60 Hz, 10 A	220-240 V, 50-60 Hz, 10 A, 120 V, 60 Hz, 10 A
Power (US) [W (Amps)]	350 (3)	350 (3)
Control	Electronically controlled	Pressure controlled
Start signal	Electrical	Pressure
Faucet with water quality indicator light	✓	N/A
Compatible with household appliances	N/A	✓
On/off [bar (psi)]	- (-)	3/4 (43.5/58)
Operation sequence (production/flush) [min]	max time 15	15/2.5
Prefiltration	Granulated Active Carbon (GAC)	Granulated Active Carbon (GAC)

Requirements on feed water to water purifier

 Do not use with water that is microbiologically unsafe or of unknown quality without adequate disinfection before or after the system.

 Only connect to the cold water supply. The temperature limits are in the table "Requirements on feed water to water purifier".

Description	Spirit 300	Spirit 300Cp
Temperature [°C (°F)]	2-35 (36-95)	2-35 (36-95)
Pressure, flowing/dynamic [kPa (bar) (psi)]	150-1000 (1.5-10) (22-145)	150-1000 (1.5-10) (22-145)
TDS (Total dissolved solids) [mg/l (ppm)]	< 1200 (< 1200)	< 1200 (< 1200)
Water flow [l/min (gal/min)]	> 6 (1.6)	> 6 (1.6)
Conductivity [µS/cm, 25 °C (77 °F)]	< 1600	< 1600
Hardness [°dH (grains/gallon)]	<10 (<10.4)	<10 (<10.4)
pH	6-9	6-9
Turbidity [FNU]	< 0.5	< 0.5
Iron Fe (II)/Fe(III) [mg/l (ppm)]	< 0.5/< 0.3 (< 0.5/< 0.3)	< 0.5/< 0.3 (< 0.5/< 0.3)
Manganese Mn [mg/l (ppm)]	< 0.2 (< 0.2)	< 0.2 (< 0.2)
Chlorine Cl ₂ [mg/l (ppm)]	< 1.0 (< 1.0)	< 1.0 (< 1.0)

TROUBLESHOOTING

How to solve simple problems

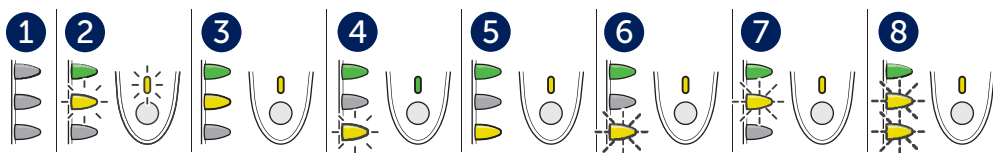

	Symptom	Cause	Solution
1	The ON light is not on.	The water purifier is not connected to power.	Connect the water purifier to power.
2	The FILTER light flashes, and the yellow light on the faucet flashes.	The filter must be replaced.	See "Replace prefilter" on page 20.
3	The FILTER light is on, and the yellow light on the faucet is on.	The water purifier has stopped. The filter must be replaced.	See "Replace prefilter" on page 20.
4	The SERVICE light flashes, and the green light on the faucet is on. The water purifier produces water.	The water quality has decreased, but is safe to drink. The water purifier will stop soon, see 5.	Contact Bluewater to replace the membrane.
5	The SERVICE light is on, and the yellow light on the faucet is on.	The water purifier has stopped. A filter replacement has caused air to come into the system.	Disconnect the water purifier from power. Reconnect it. Let the water purifier do the automatic flush.
		The water purifier has stopped. The clean water quality has become too low.	Contact Bluewater to replace the membrane.
6	The SERVICE light flashes quickly and the yellow light on the faucet is on.	The water quality meter does not function.	Contact your Bluewater dealer.
7	The water purifier makes noise because the water pressure is not sufficient. Or The FILTER light flashes quickly and the yellow light on the faucet is on.	The inlet pressure is lower than 1.5 bar during operation.	Contact your Bluewater dealer.
		The grid filter is blocked.	See "Clean the grid filter" on page 21.
		The filter is blocked.	See "Replace prefilter" on page 20.
		The low pressure restart function is active.	See "Low pressure restart function" on page 10.
8	The FILTER light and the SERVICE light flash quickly and the yellow light on the faucet is on.	The overflow protection system is activated.	Disconnect the water purifier from power, and clean the base plate. If the overflow protection is activated again, contact your Bluewater dealer.
	The water purifier does not start.	The water purifier flushes water.	Wait for 5 minutes.

Symptom	Cause	Solution
Spirit 300: The faucet light is not on.	There is a problem with the electronic faucet.	Contact your Bluewater dealer.
	The faucet cable is not connected.	Make sure that the faucet cable and connector are connected.
The flow rate from the clean water faucet is low.	The water purifier needs to be descaled.	See "Descale" on page 18.
	The clean water hose is tensioned or jammed.	Make sure that the clean water hose can move freely.
Water does not flow from the clean water faucet.	The feed water shut-off valve is closed.	Open the feed water shut-off valve.
The water smells bad.	Microbial growth in the water because the water purifier has not been used for a week or longer.	See "Use disinfectant to clean the system" on page 22.

Bluewater is a world leading water purification company. Headquartered in Stockholm, Sweden, the company helps people and businesses globally enjoy the health and wellbeing benefits of cleaner, healthier tap water. Bluewater innovates, makes and sells compact water purifiers that harness the company's patented reverse osmosis technology to remove virtually all pollutants from tap water, including lead, bacteria, pesticides, medical residues, chlorine and lime-scale.

Please visit us at bluewatergroup.com



BLUEWATER

Danderydsgatan 11
SE-114 26 Stockholm
Sweden
E: hello@bluewatergroup.com

bluewatergroup.com

